

Varenummer: 2031120M30125B2U

Beskrivelse: E+G Justerfod
GN 31-120-M30-125-B2-U

Note: U Uden møtrik, sekskant i toppen, spændeflade i bunden

Mål

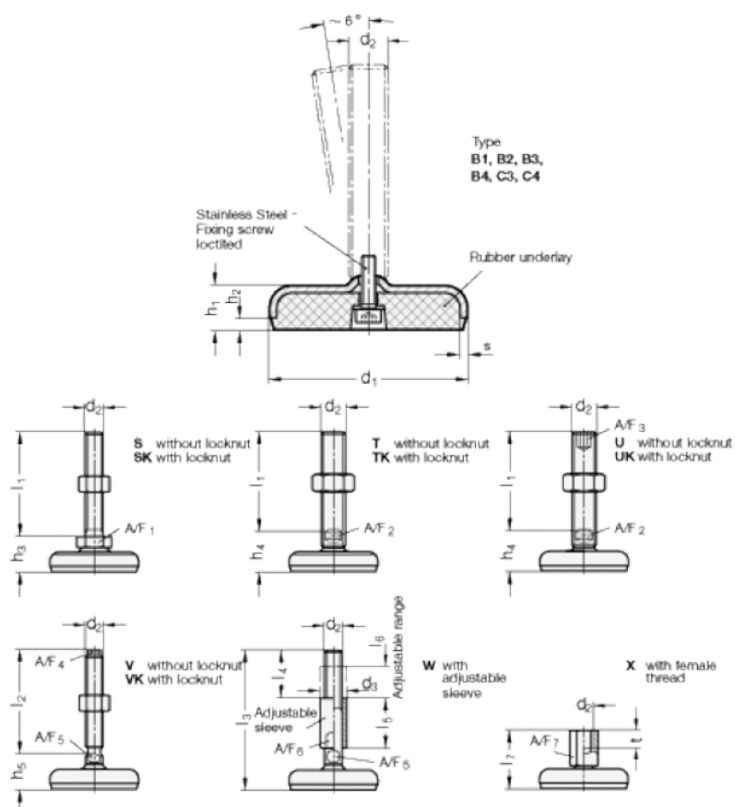

A/F2	= 24	s = 4
A/F3	= 12	
d1	= 120	
d2	= 30	
h1	= 22	
h2	= 6	
h4 +4.0/0	= 46	
l1	= 125	